

## Standard

## Theater Seating (Build it Yourself)

## Suggested Configurations

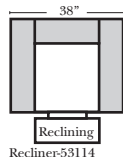
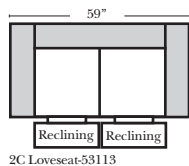
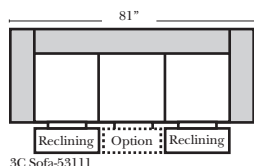
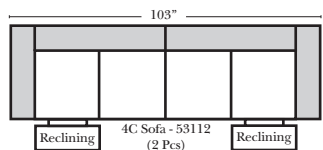

Put Orange Arrows with Tan Arrows to Create Sectional Groups

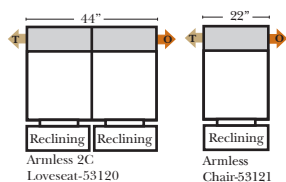
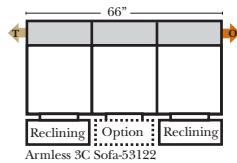
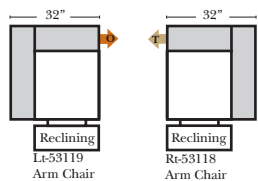
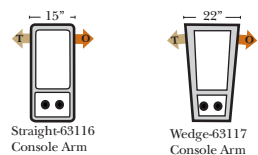

The Suggested Configurations below are only a sample of what the imagination can create, please enjoy creating the configuration that fits your lifestyle, using the ideas below and from the items on the opposite page.

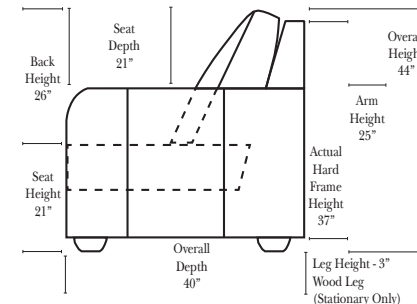
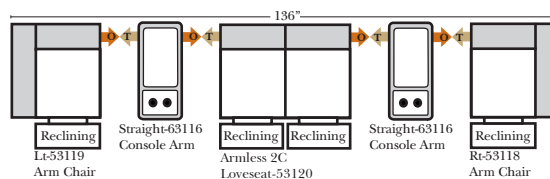
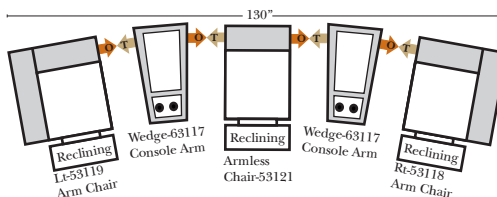

### Standards & Options

#### Standard:

- Available in Full & Top Grain Leathers
- Available in Luxury Fabrics
- All Hardwood Frames
- Wood Leg Finish - Walnut Finish (Stationary Only)
- Tassels (Included)

#### Options: (No Additional Charge)

- No. 33 Firm Foam
- Wood Leg - Cherry, Chocolate, Espresso, Honey Oak, Shadow (Stationary Only)

#### Options: (Additional Charges Apply)

- Console Table - Standard as Espresso finish (N/C Option is Honey Oak finish)
- Metal Cup Holder (MCH) - Standard Finish is Silver (N/C Option is Black or Hammered Antique Finish)
- Electronic Cup Holder (ECH) Console Arms Only (Available with Motorized Reclining Seats only)
- Sofa Center Recliner
- Motorized Recliner Mechanism
- Swivel Recliner Base
- Swivel Glider Mechanism
- Lift Chair Dual Motor Mechanism
- Saddle Bags (Black only) (Sold in pairs only)

#### Sleeper Options: (N/A at this time)



#### Note:

All Dimensions are approximate, if accuracy is crucial, please contact us for validation of the dimensions shown. However, a 1" to 2" variance can still apply due to foam and upholstery.

All items on these pages are available as Stationary (Non-Reclining)